

SERVICE INSTRUCTIONS

1. Do NOT attempt to repair or adjust any electrical or mechanical functions on this unit. Doing so will void the Warranty.
2. If you need to exchange the unit, please return it in its original carton, with a sales receipt, to the store where you purchased it. If you are returning the unit more than 30 days after the date of purchase, please see the enclosed Warranty.
3. If you have any questions or comments regarding this unit's operation or believe any repair is necessary, please call our Consumer Service Department at 1-800-323-9519 or visit our website at www.crockpot.com.

1 YEAR LIMITED WARRANTY

Sunbeam Products, Inc. doing business as Jarden Consumer Solutions or if in Canada, Sunbeam Corporation (Canada) Limited doing business as Jarden Consumer Solutions (collectively "JCS") warrants that for a period of one year from the date of purchase, this product will be free from defects in material and workmanship. JCS, at its option, will repair or replace this product or any component of the product found to be defective during the warranty period. Replacement will be made with a new or remanufactured product or component. If the product is no longer available, replacement may be made with a similar product of equal or greater value. This is your exclusive warranty. Do NOT attempt to repair or adjust any electrical or mechanical functions on this product. Doing so will void this warranty. This warranty is valid for the original retail purchaser from the date of initial retail purchase and is not transferable. Keep the original sales receipt. Proof of purchase is required to obtain warranty performance. JCS dealers, service centers, or retail stores selling JCS products do not have the right to alter, modify or any way change the terms and conditions of this warranty.

This warranty does not cover normal wear of parts or damage resulting from any of the following: negligent use or misuse of the product, use on improper voltage or current, use contrary to the operating instructions, disassembly, repair or alteration by anyone other than JCS or an authorized JCS service center. Further, the warranty does not cover Acts of God, such as fire, flood, hurricanes and tornadoes.

What are the limits on JCS's Liability?

JCS shall not be liable for any incidental or consequential damages caused by the breach of any express, implied or statutory warranty or condition.

Except to the extent prohibited by applicable law, any implied warranty or condition of merchantability or fitness for a particular purpose is limited in duration to the duration of the above warranty.

JCS disclaims all other warranties, conditions or representations, express, implied, statutory or otherwise.

JCS shall not be liable for any damages of any kind resulting from the purchase, use or misuse of, or inability to use the product including incidental, special, consequential or similar damages or loss of profits, or for any breach of contract, fundamental or otherwise, or for any claim brought against purchaser by any other party.

Some provinces, states or jurisdictions do not allow the exclusion or limitation of incidental or consequential damages or limitations on how long an implied warranty lasts, so the above limitations or exclusion may not apply to you.

This warranty gives you specific legal rights, and you may also have other rights that vary from province to province, state to state or jurisdiction to jurisdiction.

How to Obtain Warranty Service

In the U.S.A.

If you have any questions regarding this warranty or would like to obtain warranty service, please call 1-800-323-9519 and a convenient service center address will be provided to you.

In Canada

If you have any questions regarding this warranty or would like to obtain warranty service, please call 1-800-323-9519 and a convenient service center address will be provided to you.

In the U.S.A., this warranty is offered by Sunbeam Products, Inc. doing business Jarden Consumer Solutions located in Boca Raton, Florida 33431. In Canada, this warranty is offered by Sunbeam Corporation (Canada) Limited doing business as Jarden Consumer Solutions, located at 20 B Hereford Street, Brampton, Ontario L6Y 0M1. If you have any other problem or claim in connection with this product, please write our Consumer Service Department. **PLEASE DO NOT RETURN THIS PRODUCT TO ANY OF THESE ADDRESSES OR TO THE PLACE OF PURCHASE.**

To register your product, please visit us online at www.crockpot.com.

© 2008 Sunbeam Products, Inc. doing business as Jarden Consumer Solutions. All rights reserved. Distributed by Sunbeam Products, Inc. doing business as Jarden Consumer Solutions, Boca Raton, Florida 33431.
Website: www.crockpot.com.

Printed in China

122394-08

4-7 QT Portable 08EM1/9100050002406



Cook & Carry™

For use with 4-7 quart manual portable
slow cookers

Owner's Guide

Read and Keep These Instructions

www.crockpot.com

IMPORTANT SAFEGUARDS

When using electrical appliances, basic safety precautions should always be followed, including the following:

1. READ ALL INSTRUCTIONS BEFORE USING.
2. Do not touch hot surfaces. Use handles or knobs.
3. To protect against electrical shock, do not immerse cord, plug, or heating base in water or other liquid.
4. Close supervision is necessary when any appliance is used by or near children.
5. Unplug from outlet when not in use and before cleaning. Use oven mitts or allow to cool before putting on or taking off parts.
6. Do not operate any appliance with a damaged cord or plug or after the appliance malfunctions or has been damaged in any manner. Return appliance to the manufacturer (see warranty) for examination, repair, or adjustment.
7. Do not use outdoors.
8. Do not let cord hang over edge of table or counter or touch heated surfaces.
9. Do not place on or near a hot gas or electric burner or in a heated oven.
10. Extreme caution must be used when moving an appliance containing hot oil or other hot liquids. Always use oven mitts when moving your heated slow cooker.
11. Do not use appliance for other than intended use.
12. Avoid sudden temperature changes, such as adding refrigerated foods or cold liquids into a heated pot.
13. To disconnect, press/switch OFF then remove plug from wall outlet.
14. The use of accessory attachments not recommended by the manufacturer may cause injuries.
15. Keep 6 inches clear from the wall and 6 inches clear on all sides.
16. **CAUTION:** To prevent damage or shock hazard, do not cook directly in the heating base. Cook only in the stoneware provided.

SAVE THESE INSTRUCTIONS

This appliance is for **HOUSEHOLD USE ONLY**.

There are no user-serviceable parts inside. Do not attempt to service this product. A short power-supply cord is provided to reduce the hazards resulting from entanglement or tripping over a longer cord. AN EXTENSION CORD MAY BE USED WITH CARE; HOWEVER, THE MARKED ELECTRICAL RATING SHOULD BE AT LEAST AS GREAT AS THE ELECTRICAL RATING OF THE SLOW COOKER. The extension cord should not be allowed to drape over the counter or tabletop where it can be pulled on by children or tripped over unintentionally.



POLARIZED PLUG

This appliance has a polarized plug (one blade is wider than the other). To reduce the risk of electric shock, this plug is intended to fit into a polarized outlet only one way. If the plug does not fit fully into the outlet, reverse the plug. If it still does not fit, contact a qualified electrician. Do not attempt to modify the plug in any way. If the plug fits loosely into the AC outlet or if the AC outlet feels warm do not use that outlet.

IMPORTANT NOTE: Some countertop and table surfaces are not designed to withstand the prolonged heat generated by certain appliances. Do not set the heated unit on a finished wood table. We recommend placing a hot pad or trivet under your slow cooker to prevent possible damage to the surface.

NOTE: During initial use of this appliance, some slight smoke and/or odor may be detected. This is normal with many heating appliances and will not recur after a few uses.

NOTE: Please use caution when placing your stoneware on a ceramic or smooth glass cook top stove, countertop, table, or other surface. Due to the nature of the stoneware, the rough bottom surface may scratch some surfaces if caution is not used. Always place protective padding under stoneware before setting on table or countertop.

YOUR CROCK-POT® SLOW COOKER COMPONENTS

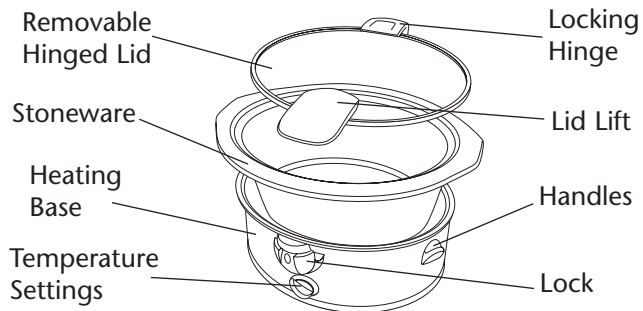

PREPARING YOUR CROCK-POT® SLOW COOKER FOR USE

Before you use your slow cooker, remove all packaging components and wash the lid and stoneware in warm, soapy water and dry thoroughly.

HOW TO USE YOUR LOCKING HINGED LID

Lid Assembly

1. Place stoneware in the heating base.
2. Mount the hinged lid to the heating base and gently snap into place by pressing down into the slot (See Fig. 1). The hinged lid was designed for convenient serving (See Fig. 2).

Lid Disassembly

1. The hinged lid must always first be removed before the stoneware can be removed. To remove the lid, simply press the button at the back of the hinge to unlock (See Fig. 3).
2. Lift up the lid (See Fig. 4)

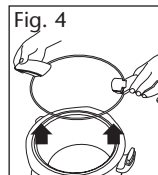
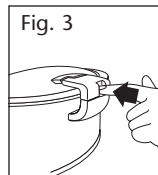
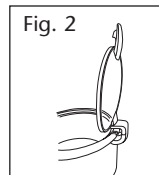
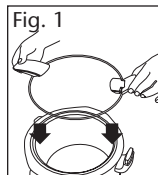

HOW TO USE YOUR LOCKING HINGED LID

Locking Lid for Transport

1. Ensure steps 1 and 2 of the Lid Assembly section have been completed.
2. Lock the lid by simply pressing the bottom of the lid lock button (See Fig. 5).
3. To unlock the lid once you have reached your destination, simply press the top of the lid lock button (See Fig. 6).

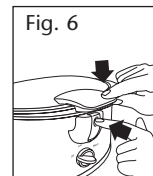
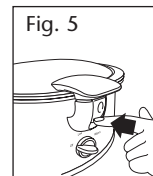

CAUTION:

NEVER attempt to lift or carry your slow cooker by the hinge, lid lift or lock. Always use the handles.

NEVER cook with the lid locked. Keep lid unlocked during use and only lock during transport.

HOW TO USE YOUR SLOW COOKER

1. Place the stoneware into the heating base, add your ingredients to the stoneware and cover with the lid (See Fig. 1).
2. Plug in your Crock-Pot® slow cooker and select the temperature setting. Refer to your specific recipe for precise cook time.
NOTE: WARM is ONLY for keeping already cooked food warm. DO NOT cook on the WARM setting. We do not recommend using the WARM setting for more than 4 hours.
3. When cooking is done, unplug your slow cooker and allow it to cool before cleaning.

HOW TO USE YOUR SLOW COOKER (CONT.)

USAGE NOTES:

- If you suspect that the power has gone out, the food may be unsafe to eat. If you are unaware of how long the power was out, we suggest you discard the food inside.
- For recipes that require a range of times, select the time closest to the setting on your slow cooker. For example, to cook a recipe calling for a cooking time of 7 to 9 hours on LOW, cook for 8 hours.
- To avoid over or under-cooking, always fill the stoneware $\frac{1}{2}$ to $\frac{3}{4}$ full and conform to recommended cook times.
- Do not overfill stoneware. To prevent spillover, do not fill stoneware higher than $\frac{3}{4}$ full.
- Always cook with the lid on for the recommended time. Do not remove the lid during the first two hours of cooking to allow the heat to build up efficiently.
- Always wear oven mitts when handling the lid or stoneware.
- Unplug when cooking is done and before cleaning.
- Removable stoneware is ovenproof and microwave safe. Do not use removable stoneware on gas or electric burner or under broiler. Refer to chart below.

Part	Dishwasher Safe	Oven Safe	Microwave Safe	Stovetop Safe
Lid	Yes	No	No	No
Stoneware	Yes	Yes, but not in the broiler	Yes	No

HOW TO CLEAN YOUR SLOW COOKER

- ALWAYS turn your slow cooker off, unplug it from the electrical outlet, and allow it to cool before cleaning.
 - The lid and stoneware can be washed in the dishwasher or with hot, soapy water. Do not use abrasive cleaning compounds or scouring pads. A cloth, sponge, or rubber spatula will usually remove residue. To remove water spots and other stains, use a non-abrasive cleaner or vinegar.
 - As with any fine ceramic, the stoneware and lid will not withstand sudden temperature changes. Do not wash the stoneware or lid with cold water when they are hot.
 - The outside of the heating base may be cleaned with a soft cloth and warm, soapy water. Wipe dry. Do not use abrasive cleaners.
- CAUTION:** Never immerse the heating base in water or other liquid.
- No other servicing should be performed.

HINTS AND TIPS

PASTA AND RICE

- For best rice results, use long grain converted rice or a specialty rice as the recipe suggests. If the rice is not cooked completely after the suggested time, add an extra 1 to 1½ cups of liquid per cup of cooked rice and continue cooking for 20 to 30 minutes.
- For best pasta results, first partially cook the pasta in a pot of boiling water until just tender. Add the pasta to the Crock-Pot® slow cooker during the last 30 minutes of cook time.

BEANS

- Beans must be softened completely before combining with sugar and/or acidic foods. Sugar and acid have a hardening effect on beans and will prevent softening.
- Dried beans, especially red kidney beans, should be boiled before adding to a recipe.
- Fully cooked canned beans may be used as a substitute for dried beans.

VEGETABLES

- Many vegetables benefit from slow cooking and are able to develop their full flavor. They tend not to overcook in your slow cooker as they might in your oven or on your stovetop.
- When cooking recipes with vegetables and meat, place vegetables in slow cooker before meat. Vegetables usually cook slower than meat in the slow cooker.
- Place vegetables near the sides or bottom of the stoneware to facilitate cooking.

HERBS AND SPICES

- Fresh herbs add flavor and color, but should be added at the end of the cooking cycle as the flavor will dissipate over long cook times.

HINTS AND TIPS (CONT.)

- Ground and/or dried herbs and spices work well in slow cooking and may be added at the beginning.
- The flavor power of all herbs and spices can vary greatly depending on their particular strength and shelf life. Use herbs sparingly, taste at end of cook cycle and adjust seasonings just before serving.

MILK

- Milk, cream, and sour cream break down during extended cooking. When possible, add during the last 15 to 30 minutes of cooking.
- Condensed soups may be substituted for milk and can cook for extended times.

SOUPS

- Some soup recipes call for large amounts of water. Add other soup ingredients to the slow cooker first then add water only to cover. If thinner soup is desired, add more liquid at serving time.

MEATS

- Trim fat, rinse well, and pat meat dry with paper towels.
- Browning meat in a separate skillet or broiler allows fat to be drained off before slow cooking and also adds greater depth of flavor.
- Meat should be positioned so that it rests in the stoneware without touching the lid.
- For smaller or larger cuts of meat, alter the amount of vegetables or potatoes so that the stoneware is always ½ to ¾ full.
- The size of the meat and the recommended cook times are just estimates and can vary depending upon the specific cut, type, and bone structure. Lean meats such as chicken or pork tenderloin tend to cook faster than meats with more connective tissue and fat such as beef chuck or pork shoulder. Cooking meat on the bone versus boneless will increase required cook times.

HINTS AND TIPS (CONT.)

- Cut meat into smaller pieces when cooking with precooked foods such as beans or fruit, or light vegetables such as mushrooms, diced onion, eggplant, or finely minced vegetables. This enables all food to cook at the same rate.
- When cooking frozen meats, at least 1 cup of warm liquid must first be added. The liquid will act as a "cushion" to prevent sudden temperature changes. An additional 4 hours on LOW or 2 hours on HIGH is typically required. For larger cuts of frozen meat, it may take much longer to defrost and tenderize.

FISH

- Fish cooks quickly and should be added at the end of the cooking cycle during last fifteen minutes to hour of cooking.

LIQUID

- For best results and to prevent food from drying or burning, always ensure an adequate amount of liquid is used in the recipe.
- Ensure the stoneware is always filled a minimum of ½ full and a maximum of ¾ full, and conform to recommended cook times.

Visit the Crock-Pot® slow cooker website at www.crockpot.com for additional hints, tips and recipes or call 1-800-323-9519.

RECIPES**BABY BACK RIBS****Serves 6-10**

2-4 racks of baby back ribs,
cut into 3-4 pieces each

2-4 cups barbecue sauce
2-3 onions, chopped

1. Place ribs in Crock-Pot® slow cooker. Top with onion and barbecue sauce.
2. Cover and cook on Low for 7-9 hours or on High for 4-5 hours, or until meat is tender.
3. To serve, cut ribs between bones and coat with extra sauce as desired.

BBQ PULLED PORK**Serves 6-8**

2½-5 pound pork loin, trimmed of fat
2-4 cups barbecue sauce

2-3 onions, chopped
6-8 hamburger buns or hard rolls

1. Place pork loin in Crock-Pot® slow cooker. Top with onion and barbecue sauce.
2. Cover and cook on Low for 7-9 hours or on High for 4-5 hours, or until meat is tender.
3. Remove pork from Crock-Pot® slow cooker and shred with a fork. Add pork back into Crock-Pot® slow cooker and coat with sauce.
4. Serve BBQ pulled pork on hamburger buns or hard rolls.

RECIPES

BEEF BOURGUIGNON

Serves 6-8

3 tablespoons flour	2 cups red or Burgundy wine
Kosher salt and pepper	1 tablespoon tomato paste
3 pounds beef chuck, cut into 1-inch cubes	2 cloves garlic, minced
3 large carrots, peeled and sliced	3 sprigs fresh thyme, stemmed
1 medium onion, sliced	1 bay leaf
6 strips cooked bacon, cut into 1-2 inch pieces	1 pound fresh mushrooms, sliced
1 10-ounce can beef broth	2 large potatoes, cut into 1-inch pieces

1. Coat beef in flour seasoned with salt and pepper. Sear beef in a skillet on stovetop (optional).
2. Place meat in Crock-Pot® slow cooker and add remaining ingredients.
3. Cover and cook on Low for 8-10 hours or on High for 5-7 hours, or until meat is tender.

LEMON HERB ROASTED CHICKEN

Serves 4-6

4-6 pound roasting chicken	½ teaspoon Kosher salt
½ cup onion, chopped	2 tablespoons fresh parsley
1-2 tablespoons butter	½ teaspoon dried thyme
Juice of one lemon	½ teaspoon paprika

1. Place the onion in the cavity of the chicken and rub the skin with butter. Place chicken in Crock-Pot® slow cooker.
2. Squeeze lemon juice over chicken and sprinkle with remaining seasonings. Cover and cook on Low 8-10 hours or on High 4-5 hours.

RECIPES

CHICKEN CACCIATORE

Serves 4-8

2-3 onions, thinly sliced	½ cup dry white wine or broth
2-4 pounds chicken (breasts or thighs), skinned	2 tablespoons capers
1 28-ounce can plum tomatoes, chopped	20 pitted Kalamata olives, chopped coarsely
Kosher salt and pepper	1 bunch fresh parsley or basil, stemmed and coarsely chopped
5 cloves garlic, minced	Cooked pasta

1. Place sliced onion in Crock-Pot® slow cooker and cover with chicken.
2. In a bowl, stir tomatoes, salt, pepper, garlic and white wine together. Pour over chicken.
3. Cover and cook on Low for 5-6 hours or on High for 3-4 hours or, or until chicken is tender.
4. Stir in capers, olives and herbs just before serving.
5. Serve over cooked pasta.

Note: Cooking chicken on the bone versus boneless will increase cook time about 30 minutes to 1 hour.

CHILI

Serves 6-8

2 large onions, chopped	1 14-ounce can diced tomatoes
5-6 cloves garlic, minced	2 jalapeños, seeded and minced
2 green peppers, chopped	1 tablespoon cumin
2-3 pounds ground beef, cooked and drained	1 teaspoon cayenne pepper
2 14-ounce cans red, black or white beans, rinsed and drained	½ cup beef broth

1. Add all ingredients to Crock-Pot® slow cooker.
2. Cover and cook on Low for 8-9 hours or on High for 4-5 hours.

RECIPES

POT ROAST

Serves 6-10

2-4 pound beef chuck pot roast	3 onions, sliced
½ cup flour	2 stalks celery, sliced
Kosher salt and pepper	1 cup mushrooms, sliced
3 carrots, sliced	1 cup beef broth or wine
3 potatoes, quartered	

1. Coat roast with ½ cup flour, salt, and pepper. Sear roast in a skillet on stovetop (optional).
2. Place all vegetables in Crock-Pot® slow cooker, except mushrooms. Add roast and spread mushrooms on top. Pour in liquid.
3. Cover and cook on Low for 10-12 hours or on High for 6-8 hours, or until tender.

SAUSAGE AND MEATBALLS

Serves 8-10

3-5 pounds sausage and meatballs, uncooked	1-2 28-ounce cans plum tomatoes in juice, chopped coarsely
6 cloves garlic, peeled and chopped	1 bunch fresh basil
1 28-ounce can crushed tomatoes	Cooked pasta
	Grated cheese

1. Brown sausage and meatballs in a skillet on stovetop (optional).
2. Add all ingredients to Crock-Pot® slow cooker except pasta and grated cheese.
3. Cover and cook on Low for 7-8 hours or on High for 4-5 hours.
4. Serve with cooked pasta and grated cheese.

RECIPES

BEEF STEW

Serves 6-8

2-4 pounds beef chuck stew meat, cut into 1-inch cubes	3 cloves garlic, minced
½ cup flour	2 bay leaves
Kosher salt and pepper	6 small potatoes, quartered
3 cups beef broth	2-3 onions, chopped
1 tablespoon Worcestershire sauce	3 celery stalks, sliced

1. Sprinkle flour, salt and pepper over meat. Place meat in Crock-Pot® slow cooker.
2. Add remaining ingredients and stir well.
3. Cover and cook on Low for 8-10 hours or on High for 5-6 hours, or until meat is tender. Stir thoroughly before serving.

EASY, HEALTHY FISH FILLET

Serves 4-6

Kosher salt and pepper	2-3 lemons, thinly sliced
2-3 pounds white fish (cod, sea bass, tilapia or catfish), skinned	Prepared salsa or olive tapenade to garnish
Fresh herbs (flat-leaf parsley, basil, tarragon, savory or a combination of all)	

1. Salt and pepper both sides of the fish and place in Crock-Pot® slow cooker. Cover top of fish with herbs and lemon slices, and tuck some under fish.
2. Cover and cook on High for approximately 30-40 minutes, or until no longer translucent. Cook times vary depending on thickness of fish.
3. Remove lemon slices and top with salsa or tapenade.